



McIntosh Laboratory, Inc. 2 Chambers Street Binghamton, New York 13903-2699 Phone: 607-723-3512 www.mcintoshlabs.com

MHA100
Headphone Amplifier
Owner's Manual



The lightning flash with arrowhead, within an equilateral triangle, is intended to alert the user to the presence of uninsulated “dangerous voltage” within the product’s enclosure that may be of sufficient magnitude to constitute a risk of electric shock to persons.

WARNING - TO REDUCE RISK OF FIRE OR ELECTRICAL SHOCK, DO NOT EXPOSE THIS EQUIPMENT TO RAIN OR MOISTURE.

IMPORTANT SAFETY INSTRUCTIONS!

PLEASE READ THEM BEFORE OPERATING THIS EQUIPMENT.

1. Read these instructions.
2. Keep these instructions.
3. Heed all warnings.
4. Follow all instructions.
5. Do not use this apparatus near water.
6. Clean only with a dry cloth.
7. Do not block any ventilation openings. Install in accordance with the manufacturer’s instructions.
8. Do not install near any heat sources such as radiators, heat registers, stoves, or other apparatus (including amplifiers) that produce heat.
9. Do not defeat the safety purpose of the polarized or grounding-type plug. A polarized plug has two blades with one wider than the other. A grounding type plug has two blades and a



AVIS RISQUE DE CHOC ELECTRIQUE - NE PAS OUVRIR.

NO USER-SERVICEABLE PARTS INSIDE. REFER SERVICING TO QUALIFIED PERSONNEL.

third grounding prong. The wide blade or the third prong are provided for your safety. If the provided plug does not fit into your outlet, consult an electrician for replacement of the obsolete outlet.

10. Protect the power cord from being walked on or pinched particularly at plugs, convenience receptacles, and the point where they exit from the apparatus.
11. Only use attachments/accessories specified by the manufacturer.
12. Use only with the cart, stand, tripod, bracket, or table specified by the manufacturer, or sold with the apparatus. When a cart is used, use caution when moving the cart/apparatus combination to avoid injury from tip-over.
13. Unplug this apparatus during lightning storms or when unused for long periods of time.
14. Refer all servicing to qualified service personnel. Servicing is required when the apparatus has been damaged in any way, such as power-



The exclamation point within an equilateral triangle is intended to alert the user to the presence of important operating and maintenance (servicing) instructions in the literature accompanying the appliance.

To prevent the risk of electric shock, do not remove cover or back. No user-serviceable parts inside.

supply cord or plug is damaged, liquid has been spilled or objects have fallen into the apparatus, the apparatus has been exposed to rain or moisture, does not operate normally, or has been dropped.

15. Do not expose this equipment to dripping or splashing and ensure that no objects filled with liquids, such as vases, are placed on the equipment.
16. To completely disconnect this equipment from the a.c. mains, disconnect the power supply cord plug from the a.c. receptacle.
17. The mains plug of the power supply cord shall remain readily operable.
18. Do not expose batteries to excessive heat such as sunshine, fire or the like.
19. Connect mains power supply cord only to a mains socket outlet with a protective earthing connection.

Thank You

Your decision to own this McIntosh MHA100 Headphone Amplifier ranks you at the very top among discriminating music listeners. You now have the best. The McIntosh dedication to precision performance assures many years of musical enjoyment. Please take a short time to read the information in this manual. We want you to be as familiar as possible with all the features and functions of your new McIntosh.

Please Take A Moment

The serial number, purchase date and McIntosh Dealer name are important to you for possible insurance claim or future service. The spaces below have been provided for you to record that information:

Serial Number: _____

Purchase Date: _____

Dealer Name: _____

Technical Assistance

If at any time you have questions about your McIntosh product, contact your McIntosh Dealer who is familiar with your McIntosh equipment and any other brands that may be part of your system. If you or your Dealer wish additional help concerning a suspected problem, you can receive technical assistance for all McIntosh products at:

McIntosh Laboratory, Inc.
2 Chambers Street
Binghamton, New York 13903
Phone: 607-723-3512
Fax: 607-724-0549

Copyright 2014 © by McIntosh Laboratory, Inc.

Customer Service

If it is determined that your McIntosh product is in need of repair, you can return it to your Dealer. You can also return it to the McIntosh Laboratory Service Department. For assistance on factory repair return procedure, contact the McIntosh Service Department at:

McIntosh Laboratory, Inc.
2 Chambers Street
Binghamton, New York 13903
Phone: 607-723-3515
Fax: 607-723-1917

Table of Contents

Safety Instructions.....	2
Thank You and Please Take a Moment	3
Technical Assistance and Customer Service.....	3
Table of Contents	3
General Information	4
Connector and Cable Information	4
Introduction	5
Performance Features	5
Dimensions	6
Installation	7
Connections:	
Rear Panel Connections.....	8
Connecting Components and Optional Loudspeakers.....	10-11
System Thru Connections	12
External Power Amplifier Connections	13
Remote Control and Front Panel:	
Remote Control Push-buttons	14
How to use the Remote Control.....	15
Front Panel Displays, Controls, Push-button and Jack	16
Setup Mode:	
How to Operate the Setup Mode	17
Default Settings	17
Firmware Version	18

Setup Mode: con't

Input Renaming	18
Speaker Size	19
Subwoofer Mode.....	19
Power Mode.....	19
Remote Control.....	20

Operation:

How to Operate the MHA100	21
Power On/Off	21
Source Selection	21
Volume Control	21

Trim Functions:

Trim Functions Introduction.....	21
Bass Boost.....	21
Balance.....	22
Trim Level.....	23
Mono/Stereo Mode	22
Meter Backlight	23
Display	23
Digital Audio (Display), Mute	23
Headphone Jack, Headphone HXD™	24
Output Control.....	24
Profile Mode.....	24-26
Power Output Meters and Power Guard.....	26
Using a Separate Power Amplifier.....	26
Optical and Coaxial Digital Inputs	27
USB Input Operation and Driver Installation	27
Installing the Software	27-28
USB Audio Driver Operation and Reset of Microprocessors	29
Resetting the MHA100 to default settings.....	27
Specifications.....	30
Packing Instructions	31

General Information

1. For additional connection information, refer to the owner's manual(s) for any component(s) connected to the MHA100.
2. Apply AC Power to the MHA100 and other McIntosh Component(s) only after all the system components are connected together. Failure to do so may cause a malfunction of system operations as the Microprocessor's Circuitry inside the components is active when AC Power is applied.
3. **The MHA100 includes an Auto Off Power Save Feature and the default setting is enabled.** For additional information including how to disable it, refer to page 19.
4. When Power Amplifier Protection Circuitry of the MHA100 has activated, the Front Panel Power Guard LEDs are illuminated continuously and the sound will be muted.
5. If the Power Transformer has overheated due to improper ventilation and/or high ambient operating temperature, AC Power is removed from the MHA100. Normal operation will resume when the operating temperature is in a safe range again.
6. The Remote Control supplied with the MHA100 is also capable of operating other McIntosh Components. These other components may include Pre-amplifiers, A/V Control Centers, Integrated Amplifiers, Source Components and Integrated Audio Systems. There is a chance the MHA100 and one of these other components may both respond to a command issued by the MHA100 Remote Control or the Remote Control supplied with the other component. This could affect operations such as Volume Up/Down and Power On/Off. Many of these other McIntosh components have the ability to utilize what is known as "Alternate Codes" to prevent them from responding to commands issued

by the MHA100 Remote Control. For additional information refer to the Owner's Manual supplied with the other McIntosh Component and look in the "Setup Section - Remote Control Codes" of the manual. In those rare instances where using the "Alternate Codes" is not possible, the Remote Control Sensor on the MHA100 can be switched Off and the Front Panel Controls can be used for operation instead of using the Remote Control. Refer to page 20.

7. For the best performance and safety, it is important to always match the impedance of the Loudspeaker to the Power Amplifier connections. Refer to pages 10 and 11.

Note: The impedance of a Loudspeaker actually varies as the Loudspeaker reproduces different frequencies. As a result, the nominal impedance rating of the Loudspeaker (usually measured at a midrange frequency) might not always agree with the impedance of the Loudspeaker at low frequencies where the greatest amount of power is required. Contact the Loudspeaker Manufacturer for additional information about the actual impedance of the Loudspeaker before connecting it to the McIntosh MHA100.

8. Sound Intensity is measured in units called Decibels and "dB" is the abbreviation.
9. When discarding the unit, comply with local rules or regulations. Batteries should never be thrown away or incinerated but disposed of in accordance with the local regulations concerning battery disposal.
10. For additional information on the MHA100 and other McIntosh Products please visit the McIntosh Web Site at www.mcintoshlabs.com.



Connector and Cable Information

XLR Connectors

Below is the Pin configuration for the XLR Balanced Input Connectors on the MHA100. Refer to the diagram for connection:

- PIN 1: Shield/Ground
- PIN 2: + Input
- PIN 3: - Input

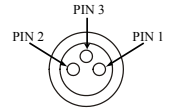

XLR Connectors (Digital Audio)

Below is the Pin configuration for the XLR Balanced Digital Audio Input Connector on the MHA100. Refer to the diagram for connection:

- PIN 1: Shield/Ground
- PIN 2: + Signal
- PIN 3: - Signal

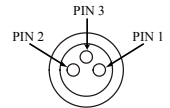

Note: When connecting to the MHA100 Digital XLR Input connector it is important to use a twisted pair shielded cable.

Power Control Connectors

The Power Control Input Jack receives Power On/Off Signals (+12 volt/0 volt) when connected to other McIntosh Components. The Power Control Output Jack sends Power On/Off Signals (+12 volt/0 volt) when connected to other McIntosh Components. An additional connection is for controlling the illumination of the Power Output Meters on McIntosh Power Amplifiers. A 3.5mm stereo mini phone plug is used for connection to the Power Control Jacks.

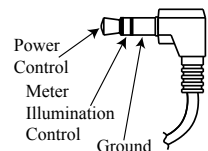

Introduction

Now you can take advantage of traditional McIntosh standards of excellence in the MHA100 Headphone Amplifier. The Power Amplifier section of the MHA100 will drive Headphones or a pair of quality Loudspeakers to a high level of performance.

The flexible Preamplifier section provides connections for various input sources, including Digital sources and music streaming from the Internet via an USB Computer connection.

The MHA100 reproduction is sonically transparent and absolutely accurate. The McIntosh Sound is “The Sound of the Music Itself.”

Performance Features

• Power Output

The MHA100 consists of a 50 watts per channel stereo Power Amplifier with less than 0.005% distortion. The McIntosh MHA100 is designed for connection of a single 8 ohm Loudspeaker per channel. The Power Amplifier uses ThermalTrak¹ Output Transistors for lower distortion and cool operation.

• Autoformer Designed for Headphones

The MHA100 is the first McIntosh Amplifier using a specially designed Autoformer for Headphones. There are three selectable impedances ranges, allow connection of Headphones from 8 ohms thru 600 ohms.

• HXD™ for Headphones

The MHA100 Headphone Crossfeed Director Circuitry (HXD™) improves the sound localization for Headphone Listening. HXD™ restores the directionality component of the spatial sound stage normally heard with Loudspeaker listening.

• Automatic Output Switching

The MHA100 has a Front Panel one-quarter inch Headphone Jack for private listening. Loudspeaker Listening is automatically switched Off when Headphones are connected.

• Four Forms of Protection

McIntosh Sentry Monitor power output stage protection circuits ensure the MHA100 will have a long and trouble free operating life. The Sentry Monitor also protects the Headphones in the event of an impedance mismatch. Built-in Thermal Protection Circuits guard against overheating. Direct Current Detection and Protection is provided for both Headphones and Loudspeakers

• Power Guard

The patented McIntosh Power Guard circuit prevents amplifier clipping and protects your valuable Headphones and Loudspeakers.

• Electronic Input Switching and Balanced Input

The Preamplifier uses Logic Circuits controlling Electromagnetic Switches on all inputs and operating functions for reliable, noiseless, distortion free switching. There is a Balanced Input for connection of a source component.

• Digital Audio Inputs

The MHA100 has Coaxial, Optical, Balanced Digital (AES/EBU) and USB Digital Inputs to decode PCM Signals from an external source. The MHA100 upsamples the Digital Signal to 192kHz with 32Bit resolution before the Digital to Analog process begins.

• Multifunction OLED Display

The Front Panel Display indicates source selection, volume levels, trim settings and setup functions.

• Illuminated Meters

The Illuminated Power Output Meters on the MHA100 are peak responding, and indicate the output of the amplifier.

• Power Control and Remote Control

The Power Control Output connection provides convenient Turn-On/Off of McIntosh Source Components.

• Special Power Supply

The large Power Transformer, multiple large filter capacitors and regulated Power Supply ensures stable noise free operation even though the power line varies.

• McIntosh Custom Binding Posts

McIntosh Patented gold plated output terminals deliver high current output. They accept large diameter wire and spade lugs. Banana plugs may also be used only in the United States and Canada.

• Glass Front Panel and Super Mirror Chassis

The MHA100 has the famous McIntosh Illuminated Glass Front Panel and Stainless Steel Super Mirror Finish Chassis. This ensures the pristine beauty of the MHA100 will be retained for many years.

• Fiber Optic Solid State Front Panel Illumination

The even Illumination of the Front Panel is accomplished by the combination of custom designed Fiber Optic Light Diffusers and extra long life Light Emitting Diodes (LEDs).

¹ThermalTrak™ and ON Semiconductor are trademarks of Semiconductor Components Industries, LLC

Dimensions

The following dimensions can assist in determining the best location for your MHA100. There is additional information on the next page pertaining to installing the MHA100 into cabinets.

Front View of the MHA100

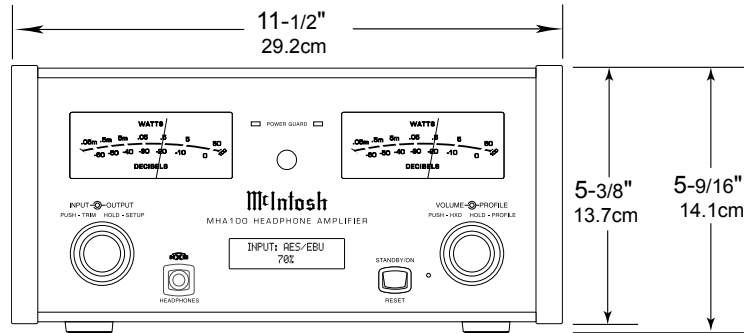

Side View of the MHA100

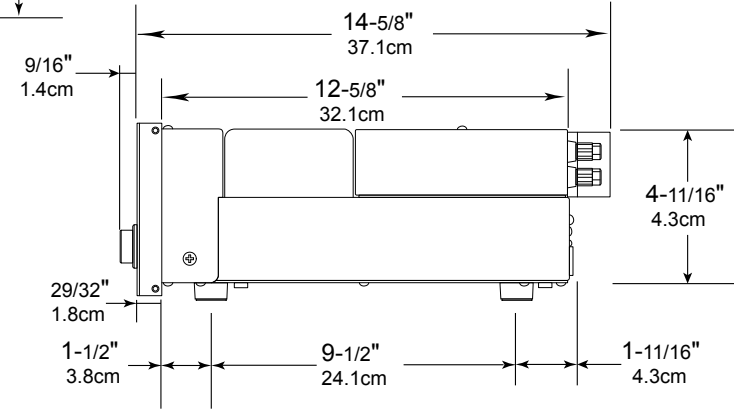

Rear View of the MHA100

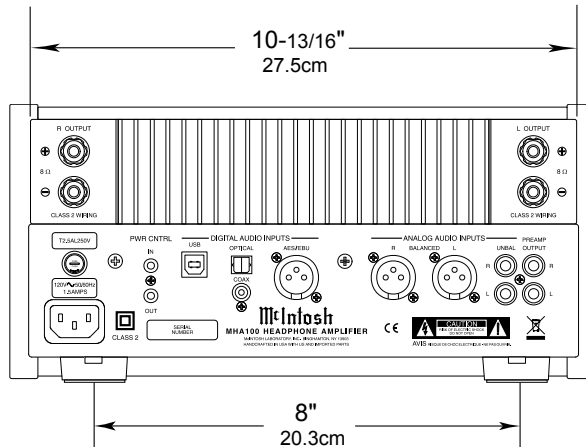

Installation

The MHA100 Headphone Amplifier is designed to be placed upright on a table or shelf, standing on its feet. The required ventilation requirements are shown. Always provide adequate ventilation for your MHA100. Cool operation ensures the longest possible operating life for any electronic instrument. Do not install the MHA100 directly above a heat generating device, such as a Power Amplifier. Allow at least 6 inches (15.3cm) above the top, 5/8 inches (1.6cm) below the bottom and 2 inch (5.1cm) on each side of the Amplifier, so that airflow is not obstructed. Allow 19 inches (48.3cm) of depth for airflow and cable connections.

MHA 100 Front View

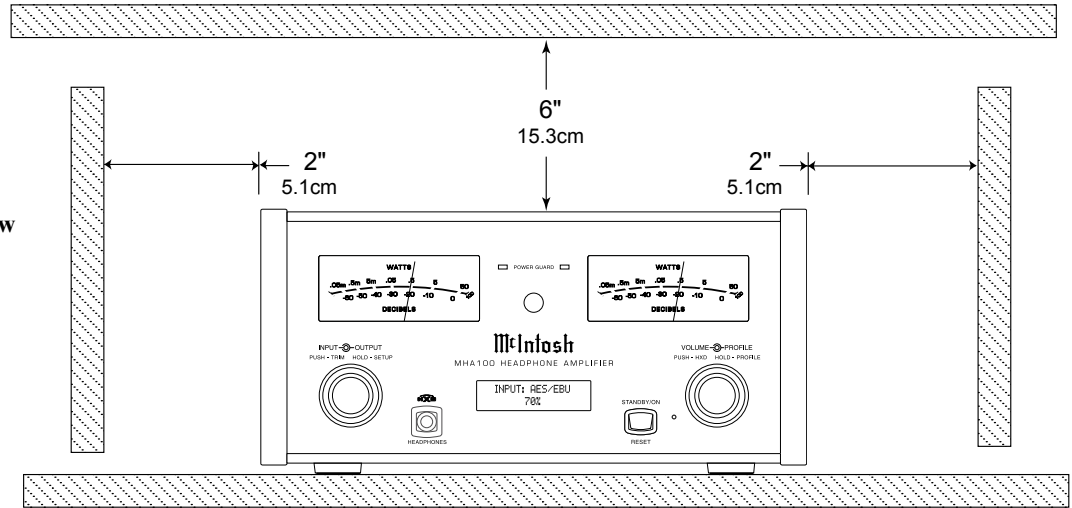

MHA 100 Side View

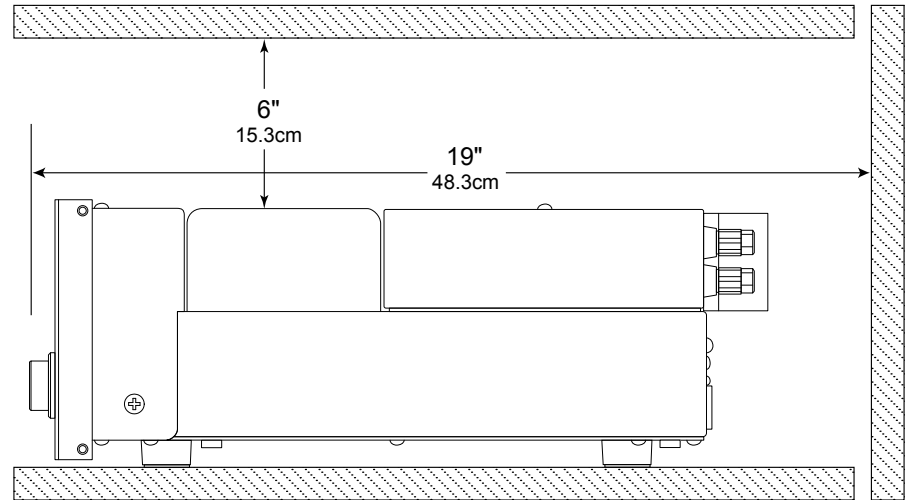

RIGHT OUTPUT
connections for an
8 ohm Loudspeaker

LEFT OUTPUT
connections for an
8 ohm Loudspeaker

DIGITAL AUDIO INPUTS
for components with Digital
Optical, Coaxial and Balanced
Digital (AES/EBU) Outputs
sending digital audio signals

Main Fuse holder, refer to
information on the back
panel of your MHA100 to
determine the correct fuse
size and rating

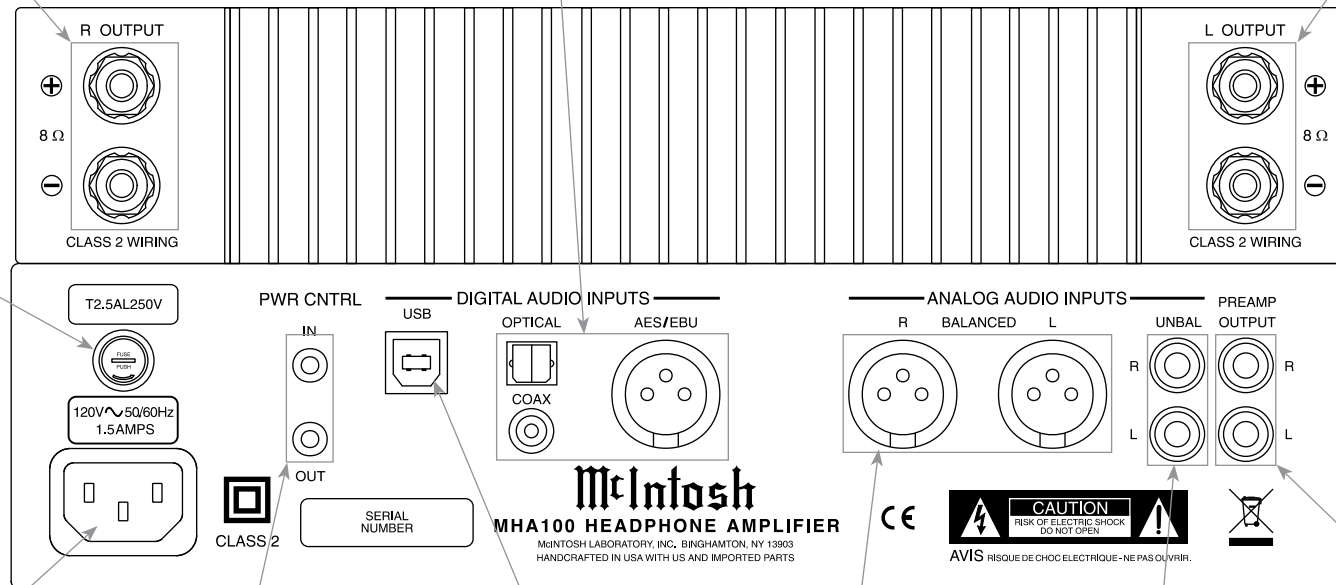

PWR CNTRL (Power Control) IN
receives a turn On/Off signal from a
McIntosh Component; PWR CNTRL
OUT sends a turn On/Off signal to an
other McIntosh Component

BALANCED INPUT
accept high level signal
from a source with a
balanced output

PREAMP OUTPUT
sends signals to an ex-
ternal Power Amplifier
or Powered Subwoofer

Connect the MHA100 power cord
to a live AC outlet. Refer to infor-
mation on the back panel of your
MHA100 to determine the correct
voltage for your unit

USB Digital Audio
Input for connection to
a computer

UNBALANCED INPUT
accept high level signal
from a source with an
unbalanced output



Connecting Components

The MHA100 has the ability to automatically switch power On/Off to McIntosh Source Components via the Power Control connection.

The connection instructions below, together with the MHA100 Connection Diagram on the next page is an example of a typical audio system. Your system may vary from this, however the actual components would be connected in a similar manner. For additional information refer to “Connector and Cable Information” on page 4.

Note: When the MHA100 is being added to an existing Audio (or Audio/Video) System, please proceed to page 12. If the MHA100 will be used with an external Power Amplifier, please refer to page 13.

Power Control Connections:

1. Connect a Control Cable from the MHA100 PWR CTRL (Power Control) OUT Jack to the Power Control In on the Tuner.
2. Connect a Control Cable from the Tuner Power Control Out Jack to the Disc Player Power Control In Jack.
3. Connect any additional McIntosh Components in a similar manner, as outlined in steps 1 thru 2.

Audio Connections:

4. Connect the Audio Cable from the MHA100 UNBAL 1 L & R jacks to the Disc Player Fixed Audio Output Jacks.

Note: The Balanced Input may be used instead of the UNBAL Unbalanced Inputs.

5. Connect any additional Components in a similar manner, as outlined in step 4.

Optional Digital Audio Connections:

6. Connect an Coaxial Cable from the MHA100 DIGITAL AUDIO INPUT COAX connector to the Digital Audio Out Optical Connector on the Tuner.

Note: The OPTICAL Input (on the MHA100 and on the

Tuner) may be used instead of the Coaxial Connections.

Optional USB Connection:

7. Connect a USB cable with (type A to type B) connectors from the MHA100 USB Input to an available USB connector on a Computer.

Output Terminals

When connecting the Loudspeaker Hookup Cables to the MHA100 Output Terminals please follow the steps below:

1. Rotate the top of the Output Terminal Post counterclockwise until an opening appears. Refer to figures A and B.
2. Insert the Loudspeaker hookup cable into the Output Terminal Post opening or the cable spade lug around the center post of the Output Terminal. Refer to figure C.
3. Rotate the top of the Output Terminal Post clockwise until it is finger tight. Refer to figure D.
4. Place the supplied McIntosh Wrench over the top of the Output Terminal and rotate it one quarter of a turn (90°) to secure the Loudspeaker Cable Connection. **Do not over tighten.** Refer to figure E.

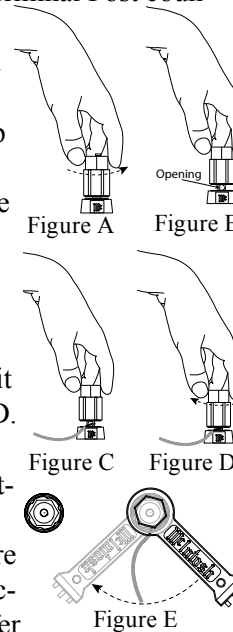

Warning: Loudspeaker terminals are hazardous live and present a risk of electric shock. For additional instruction on making Loudspeaker Connections contact your McIntosh Dealer or McIntosh Technical Support.

The McIntosh MHA100 Power Amplifier Circuitry is designed for a single 8 ohms Loudspeaker connected to the Right and Left Output Terminals.

The recommended cable size is shown below:

Cable Distance vs American Wire Gauge (Size)			
Loudspeaker Impedance	25 feet (7.62 meters) or less	50 feet (15.24 meters) or less	100 feet (30.48 meters) or less
8 Ohms	16AWG	14AWG	12AWG

1. Prepare the Loudspeaker Hookup Cable for attachment to the MHA100:

Bare wire cable ends:

Carefully remove sufficient insulation from the cable ends, refer to figures F, G & H. If the cable is stranded, carefully twist the strands together as tightly as possible.

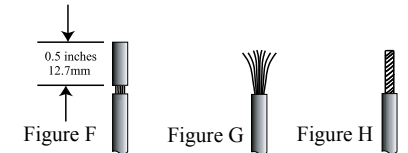

- Notes:*
1. If desired, the twisted ends can be tinned with solder to keep the strands together.
 2. The prepared bare wire cable ends may be inserted into spade lug connectors.
 3. Banana plugs are for use in the United States and Canada only.

Banana Plugs are for use in the United States and Canada only:

2. Attach the previously prepared bare wire cable ends into the banana plugs and secure the connections. Refer to figure I.

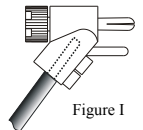

How to Connect Optional Loudspeakers

Caution: Do not connect the AC Power Cord to the MHA100 Rear Panel until after the Loudspeaker Connections are made. Failure to observe this could result in Electric Shock.

3. Rotate the Output Terminal Post clockwise until it is finger tight. Refer to figure J. Then using the McIntosh Wrench, rotate the top of the Output Terminal one quarter of a turn (90°). **Do not over tighten.** Refer to figure E.

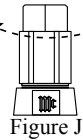

4. Referring to figure K, connect the Loudspeaker hookup cables with banana plugs into the hole at the top of the terminal to the MHA100 Negative Output Terminal and Positive Output Terminal to the Loudspeaker Terminal Connections being careful to observe the correct polarities.

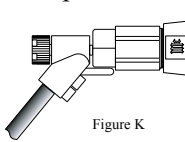

5. Connect the MHA100 power cord to an active AC outlet.

Spade Lug or Wire Connections:

6. Connect the Loudspeaker hookup cables to the MHA100 Negative Output Terminal and Positive Output Terminal to the Loudspeaker Terminal Connections being careful to observe the correct polarities. Insert the spade lug connector or prepared section of the cable end into the terminal side access hole, and tighten the terminal cap until the cable is firmly clamped into the terminals so the lugs or wire cannot slip out. Refer to figures L and M.

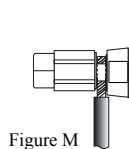
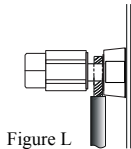

7. Connect the MHA100 power cord to an active AC outlet.

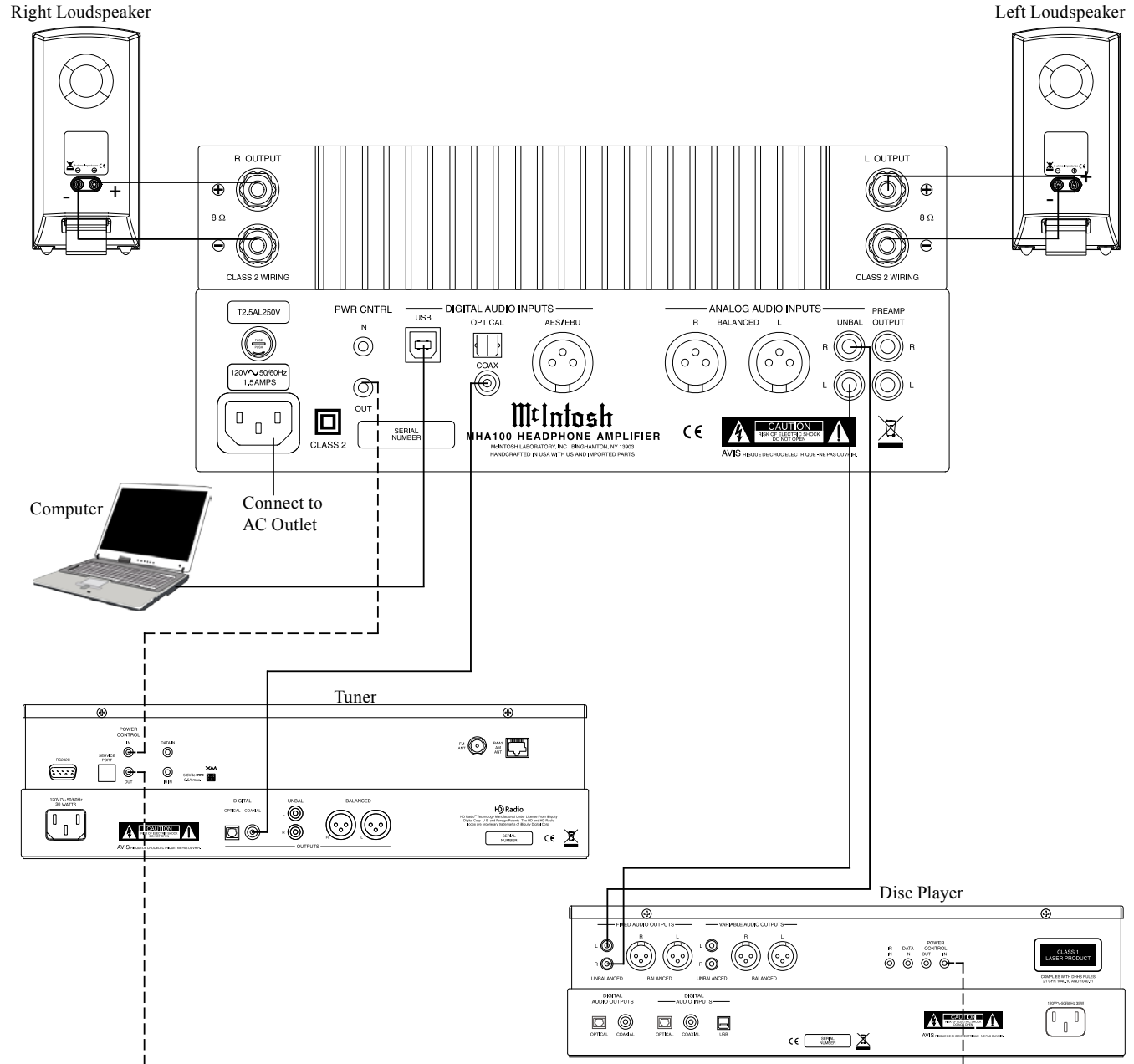

System Thru Connections

The MHA100 can also be part of an existing Audio or Audio/Video Sound System. The MHA100 allows connection of Headphones for private listening. It can also drive Loudspeakers in a second room. The MHA100 becomes active when the Main Preamplifier or Audio/Video Controller is On. In the example below, the MHA100 will go On/Off when the OUTPUT 2 function of the Preamplifier is activated using the Power Control 2 connections.

1. Connect Audio Cables from the Preamplifier OUTPUT 2 jacks to the MHA100 Analog Audio UNBAL jacks.

Note: The Preamplifier Balanced OUTPUT 2 connected to the MHA100 BALANCED Input may be used instead of the unbalanced connections.

2. Connect a Control Cable from the Preamplifier POWER CONTROL OUTPUT 2 jack to the MHA100 PWR CTRL (Power Control) IN Jack.

For additional operational information when using the System Thru Connection with the MHA100 and Main Preamplifier or Audio/Video Controller, refer to “System Thru Operation” on page 26

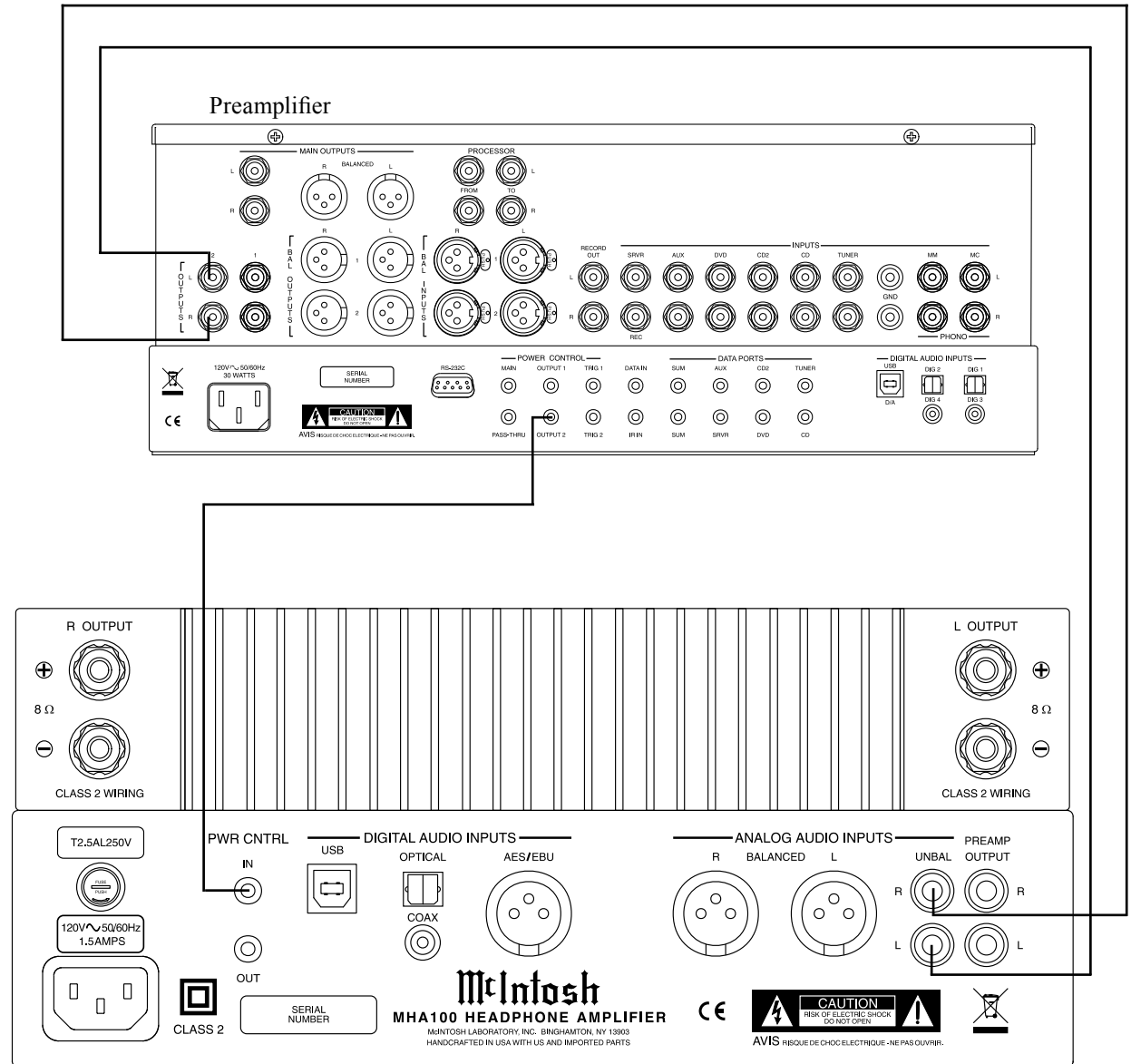

External Power Amplifier Connections

The MHA100 has the ability to drive an External Power Amplifier. In the example below, the MHA100 automatically switches the External Power Amplifier On/Off via Power Control function.

1. Connect Audio Cables from the MHA100 PRE-AMPLIFIER OUTPUT jacks to the External Power Amplifier IN (Left and Right) jacks.
2. Connect a Control Cable from the MHA100 PWR CNTRL (Power Control) OUT jack to the External Power Amplifier Power Control IN Jack.
3. Refer to page 10 for connecting other component(s) to the MHA100.
4. Refer to the External Power Amplifier Owner's Manual for connection of Loudspeakers.

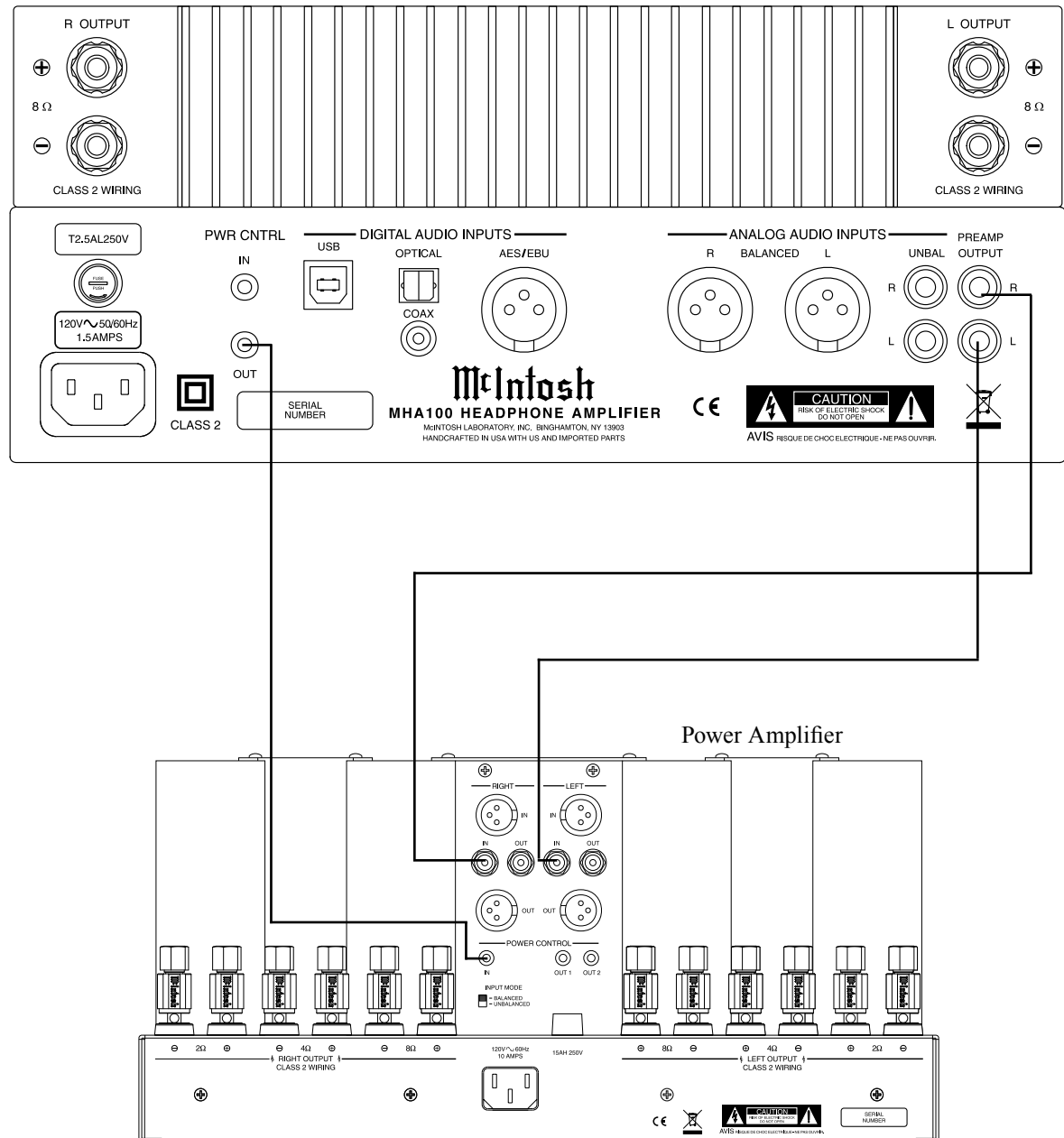

Adjusts or Selects the active TRIM function also manually tune down the dial with contemporary McIntosh Tuners

Directional Push-buttons - Up, Down, Left and Right

Adjusts or Selects the active TRIM function also manually tune up the dial with contemporary McIntosh Tuners

Press to activate TRIM Mode

Scrolls through TRIM Functions

Scrolls through TRIM Functions

Decreases the volume level

Increases the volume level

Selects the desired INPUT

LED illuminates during the time a remote command is sent to the MHA100

Mutes and unmutes the audio

Powers the MHA100 ON or OFF

Selects the PREVIOUS ⏮ Station Preset on contemporary McIntosh Tuners

Selects the NEXT ⏭ Station Preset on contemporary McIntosh Tuners

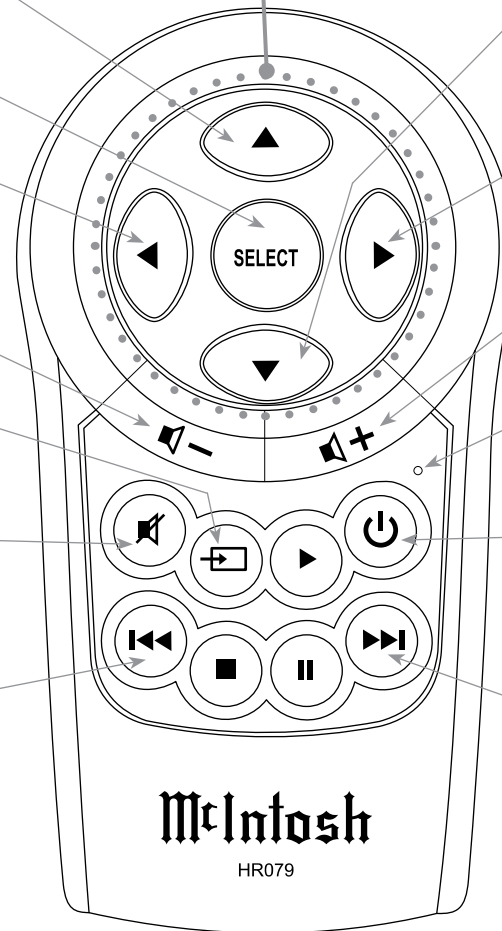

Note: Push-buttons whose function is not identified above are for use with other McIntosh Products.

How to use the Remote Control



The supplied Remote Control performs the various Operating Functions for the MHA100 Headphone Amplifier.

Note: Refer to the "How to Operate" Section of this manual for additional information.

Input Source Selection

Press the Push-button  to select the desired program source.

Volume

Press the + or - Push-buttons to increase or decrease the listening level.





Mute



Press the  (Mute) Push-button to mute the audio and a second time to resume listening.

Select Push-Button



Press the Select Push-button to activate the TRIM Mode. Then use the Directional Push-Buttons to select a Trim Mode Function and make changes.

Directional Push-Buttons

After having pressed the SELECT Push-button, press the   (Left or Right) Push-buttons to scroll through the various Trim Functions. Then press the   (Up or Down) Push-buttons to make a change to the current Trim Setting.

Note: If a contemporary McIntosh Tuner is used with the MHA100 the   (Up or Down) on the Remote Control will allow for manual tuning of stations. Refer to "General Information, note 6" on page 4 for additional information.

Back and Next

When using an optional contemporary McIntosh Tuner with the MHA100, select the next Station Preset by press the  Push-button. Select the previous Station Preset by pressing the  Push-button.



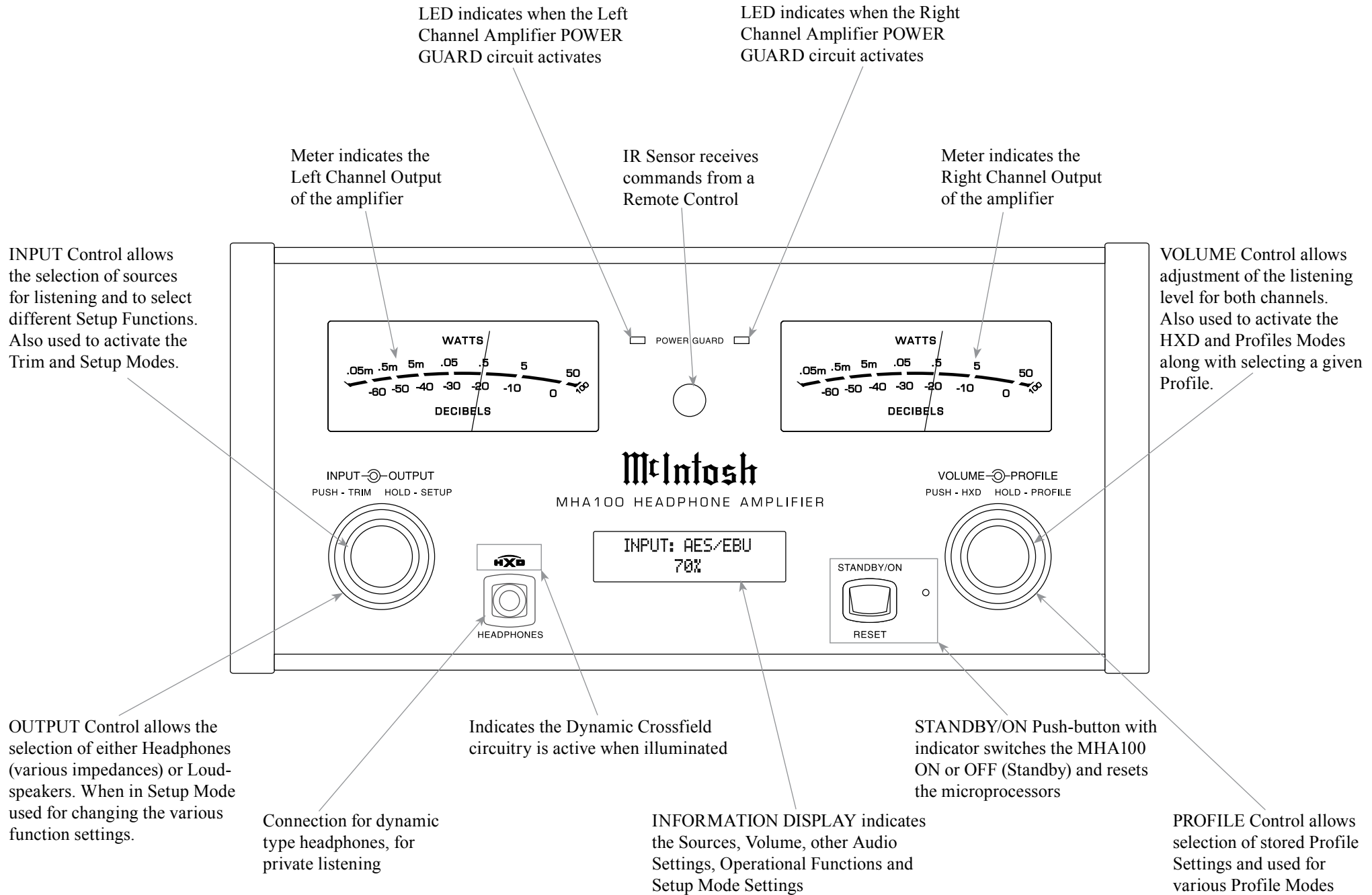

How to Operate the Setup Mode

Your McIntosh MHA100 has been factory configured for default operating settings that will allow immediate enjoyment of superb audio without the need for further adjustments. If you wish to make changes to the factory default settings, a Setup Feature is provided to customize the operating settings using the Front Panel Display. Refer to the MHA100 Front Panel Illustration on the previous page while performing an introduction into operating the Setup Mode, follow the steps below.

Note: If the MHA100 is currently On, proceed to step 2.

1. Press the STANDBY/ON Push-button on the Front Panel or press the  (Power) Push-button on the Remote Control to switch On the MHA100. The MHA100 will go through a brief startup initialization with the Front Panel Display indicating the last used input and volume setting. This is followed by the volume setting indication starting at zero and then increasing to the last used volume setting. Refer to figure 1.

The front panel display shows the text "INPUT: UNBAL" on the top line and "20%" on the bottom line.

Figure 1

2. Press and hold in the INPUT CONTROL until the Front Panel Display indicates “MHA100 V_._, S/N: _____”. The information indicated on the Front Panel Display includes the Model Number, Firmware Version and the Serial Number for this unit; see page 18 for additional information. Refer to figure 2.

The front panel display shows the text "MHA100 V_._" on the top line and "S/N: _____" on the bottom line.

Figure 2

3. Now rotate the INPUT CONTROL Clockwise until the Front Panel Display indicates “McIntosh USB AUDIO, V_._ Firmware”. Refer to figure 3 and to page 18 for additional information.

The front panel display shows the text "MLI USB Audio" on the top line and "V_._" on the bottom line.

Figure 3

4. Next, rotate the INPUT CONTROL Clockwise again until the Front Panel Display indicates “SOURCE: UNBAL, NAME: UNBAL” Refer to figure 4.

The front panel display shows the text "INPUT: UNBAL" on the top line and "NAME: UNBAL" on the bottom line.

Figure 4

5. Rotate the INPUT CONTROL Clockwise again to select other Setup Functions. Refer to pages 18 thru 20.
6. To exit from the Setup Mode, press the INPUT CONTROL and the Front Panel Display will revert back to its normal display. Refer to figure 1.

Default Settings

The Default Settings Chart below indicates the Function Name, Default Setting and the Page Number for additional information.

Default Settings		
Function Name	Setting	Page No.
MHA100	V_._ S/N: _____	18
McIntosh USB Audio	V_._	18
INPUT NAME (Re-assign Input Names)	INPUT: _____ NAME: _____	18
SPEAKER MODE	LARGE	19
SUBWOOFER MODE	DISABLED	19
POWER MODE (Auto Off)	ON	20
REMOTE CONTROL	ENABLED	20

Note: Setup Mode operations should be performed in the order they appear in the Setup Menu as they are interactive.



Firmware Version

The MHA100 functionality is controlled by internal software that is known as Firmware. The MHA100 has two different Firmwares, one is the “System Firmware” (responsible for the basic operation of the MHA100) and the other known as USB Audio Firmware (responsible for the “USB Connection and Conversion” of a Digital Audio Signal from the Computer). The Version of the Firmwares in the MHA100 can be identified at any time by utilizing the Setup Mode.

1. Press and hold the INPUT CONTROL until the Front Panel Display indicates “MHA100 V_.__, S/N: _____”. The number after the “V” is the firmware version and the number after the “S/N” is the serial number of the unit. Refer to figure 2.



Figure 2

2. Rotate the INPUT CONTROL Clockwise until the Front Panel Display indicates “MLI USB AUDIO, V_ . _ _”. The number after the “V” is the USB Audio Firmware version”. Refer to figure 3.



Figure 3

3. To exit from the Setup Mode, press the INPUT CONTROL and the Front Panel Display will revert back to its normal display.

Input Renaming

The MHA100 Default Input Names (UNBAL, BALANCED, OPTICAL, COAX and AES/EBU as indicated on the Front Panel Display) can be customized with a different name up to eight characters long (My Phone, MCD550, etc.). The available characters for renaming the input include the following: ! < > * , / - _ 0 1 2 3 4 5 6 7 8 9 a b c d e f g h i j k l m n o p q r s t u v w x y z A B C D E F G H I J K L M N O P Q R S T U V W X Y Z .

In the following example, the UNBAL Input will be renamed to “MY-PHONE”.

1. Press and hold the INPUT CONTROL until the Front Panel Display indicates the Model, Firmware Version and Serial Number. Refer to figure 2. Then rotate the INPUT CONTROL and select the Setup Menu item “INPUT: UNBAL, NAME: UNBAL”. Refer to figure 4.



Figure 4

Note: If the UNBAL Input is not displayed, press the VOLUME Control repeatedly until it is displayed.

2. Press and hold in the VOLUME Control until the character “U” of the “NAME: UNBAL” starts flashing. Refer to figure 5.



Figure 5

3. Rotate the PROFILE Control until the character “M” appears. Refer to figure 6.
4. Rotate the OUTPUT Control until the character “N” of the “NAME: UNBAL” starts flashing. Refer to figure 7.



Figure 6



Figure 7

5. Rotate the PROFILE Control until the character “Y” appears. Refer to figure 8.



Figure 8

6. Repeat steps 3 thru 5 until the new name of “MY-PHONE” is indicated on the Front Panel Display. Refer to figures 9 thru 11.



Figure 9



Figure 10



Figure 11

7. To save the new Input Name press and hold the VOLUME Control until the word SAVED appears momentarily on the Front Panel Display. Refer to figure 12.



Figure 12

Record any changes made to the various default Input Names in the following chart for future reference.

- To exit from the Setup Mode, press the INPUT CONTROL and the Front Panel Display will revert back to its normal display.

Input Renaming	
Default Input Name	New Input Name
UNBAL	
BALANCED	
OPTICAL	
COAX	
AES/EBU	
USB	

Speaker Size

The MHA100 allows for the connection of Loudspeakers with different performance capabilities. One of the difference in Loudspeaker performance is the ability to reproduce bass frequencies down to 35Hz within -3dB of the midrange frequencies.

The MHA100 provides two different settings, LARGE and SMALL. The LARGE listing refers to the Loudspeaker's capability for reproducing bass frequencies down to 35Hz within -3dB of the midrange frequencies. If a Loudspeaker can not reproduce bass frequencies down to 35Hz within -3dB of the midrange frequencies, it is considered SMALL.

In the following example, the Speaker Size default setting of LARGE will be changed to SMALL:

- Press and hold the INPUT CONTROL until the Front Panel Display indicates the Model, Firmware Version and Serial Number. Refer to figure 2. Then rotate the INPUT CONTROL and select the Setup Menu item "SPEAKER MODE, Large". Refer to figure 13.



Figure 13

- Rotate the OUTPUT Control until the Front Panel Display indicates "SPEAKER MODE, Small". Refer to figure 14.



Figure 14

- To exit from the Setup Mode, press the INPUT CONTROL and the Front Panel Display will revert back to its normal display.

Subwoofer Mode

The MHA100 is designed to work with an external Powered Subwoofer. The subwoofer would be used when the Loudspeakers connected to MHA100 Output Terminals do not have the ability to reproduce bass frequencies down to 35Hz (within -3dB of the midrange frequencies).

The MHA100 provides two different Subwoofer Mode settings, "Disabled" and "Enabled". The Default Setting of "Disabled" provides a Stereo Signal at the PREAMPLIFIER OUTPUT Jacks. When the setting is changed to "Enabled" the Left and Right channel signals are combined into a monaural signal available at both PREAMP OUTPUT Jacks. In the following example, the Subwoofer Mode default setting of DISABLED will be changed to Enable:

- Press and hold the INPUT CONTROL until the Front Panel Display indicates the Model, Firmware Version and Serial Number. Refer to figure 2. Then rotate the INPUT CONTROL and select the Setup Menu item "SUBWOOFER MODE, Disabled".

Refer to figure 15.



Figure 15

- Rotate the OUTPUT Control until the Front Panel Display indicates "SUBWOOFER MODE, Enabled". Refer to figure 16.



Figure 16

Note: When the MHA100 Subwoofer Mode is set to "ENABLED" it is important the Powered Subwoofer internal crossover frequency be set to 80Hz. It is recommended the Professionals at your McIntosh Dealer, who are skilled in all aspects of room acoustics be involved when the MHA100 is used with a Powered Subwoofer and any associated audio equipment.

- To exit from the Setup Mode, press the INPUT CONTROL and the Front Panel Display will revert back to its normal display.

Power Mode

The MHA100 incorporates an Auto Off Feature, which automatically places the preamplifier into the Power Saving Standby/Off Mode. This occurs approximately 30 minutes after there has been an absence of audible audio signals on the selected input (on either channel) or user activity (includes changes to any of the Operation Functions such as source selection, volume adjustment, etc). If it is desirable to disable the Auto Off Feature perform the following steps:

- Press and hold the INPUT CONTROL until the Front Panel Display indicates the Setup Mode is

Power Mode, con't

active. Then rotate the INPUT CONTROL until the Setup Menu item “POWER MODE, Auto Off: On” appears on the Front Panel Display. Refer to figure 17.



Figure 17

2. Rotate the OUTPUT Control until “POWER MODE, Auto Off: Off” appears on the Front Panel Display. Refer to figure 18.



Figure 18

3. To exit from the Setup Mode, press the INPUT CONTROL and the Front Panel Display will revert back to its normal display.

Remote Control

The Front Panel IR Sensor used for Remote Control Operation can be disabled in the event there is a conflict with another McIntosh component located in the same room as the MHA100. Refer to “General Information, note 6” on page 4 for additional information. Disable the Front Panel IR Sensor by performing the following steps:

1. Press and hold the INPUT CONTROL until the Front Panel Display indicates the Model, Firmware Version and Serial Number. Then rotate the INPUT CONTROL and select the Setup Menu item “REMOTE CONTROL, Enabled”. Refer to figure 19.



Figure 19

2. Rotate the OUTPUT Control until the Front Panel-Display indicates “REMOTE CONTROL, Disabled”. Refer to figure 20.



Figure 20

3. To exit from the Setup Mode, press the INPUT CONTROL and the Front Panel Display will revert back to its normal display.



How to Operate the MHA100

Power On and Off

The Red LED beside the STANDBY/ON Push-button lights to indicate the MHA100 is in Standby mode. To switch ON the MHA100, press the STANDBY/ON Push-button on the Front Panel or press the  (Power) Push-button on the Remote Control. The MHA100 will go through a brief startup initialization, with the Front Panel Display indicating the last used input and volume setting. This is followed by the volume setting indication starting at zero and then increasing to the last used volume setting. Refer to figures 50, 51 and 52. To switch OFF the MHA100, press the STANDBY/ON Push-button on the Front Panel or the OFF Push-button on the Remote Control.



Figure 51

Note: For an explanation of the Remote Control Push-button functions, refer to pages 14 and 15.

Source Selection

Rotate the INPUT Control to select the desired input

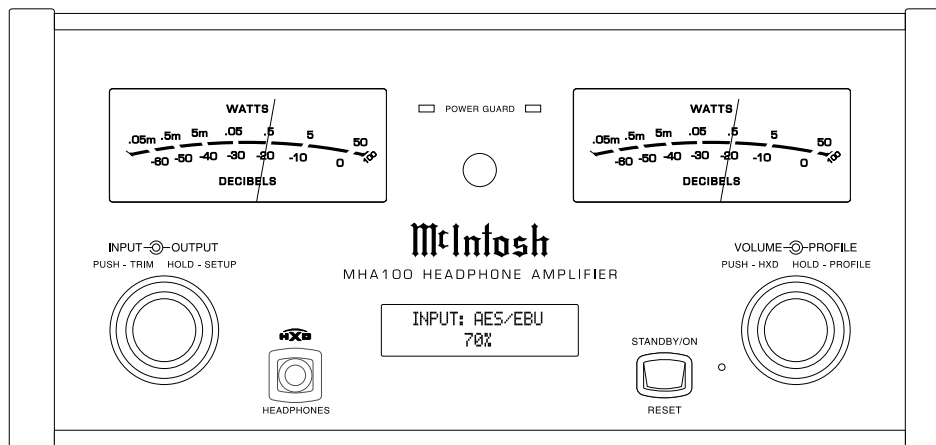



Figure 50

or press the appropriate push-button on the Remote Control. Refer to figures 50 and 53.

Volume Control

Rotate the Front Panel VOLUME Control or use the Up  (+) or Down  (-) Push-buttons on the Remote Control for the desired listening level. Refer to figures 50 and 52.

Trim Functions Introduction

The MHA100 has various Trim Selections with Adjustments. The Trim Functions include Bass Boost, Balance, Level (Input Trim), Mono/Stereo, Meter Backlight, Display (Information) and Digital Audio (Display Information). The Bass Boost, Balance, Level (Input Trim), Mono/Stereo, Trim Settings are stored in memory independently for each Input Selected, the other Trim Settings are the same for all inputs.

The selection and adjustment of all Trim Functions may be performed by first Momentarily pressing the Front Panel INPUT Control. Then rotate the INPUT Control to select the desired Trim Function. This is followed by rotating the OUTPUT Control to make a

change/adjustment in the Trim Setting. To verify a TRIM Setting without changing it, press the INPUT Control and then Rotate the INPUT Control to select the desired Trim Function. After approximately 5 seconds the Display returns to indicate the Input Selection and Volume Level.

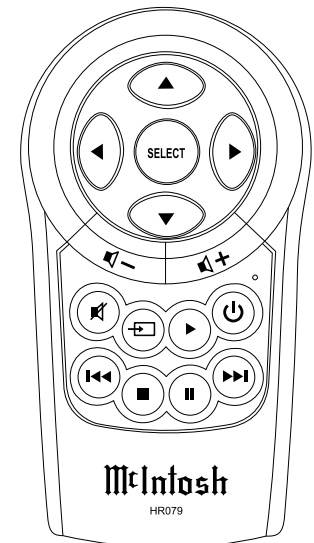

Figure 52

BASS BOOST

The Intensity of the Low Frequencies in the music can be increased by using the Bass Boost Trim Function. To make an adjustment perform the following:

1. Momentarily press the Front Panel INPUT Control to enter the TRIM Mode. Then rotate the INPUT Control until “BASS BOOST_dB” appears on the Front Panel Display. Refer to figure 53.



Figure 53

2. Rotate the OUTPUT Control to change the Bass Boost, the range of adjustment is from 0dB to +12.5 dB in 2.5 dB steps. Refer to figure 54.

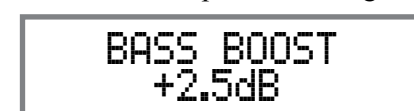

Figure 54



How to Operate the MHA100, con't

After approximately 5 seconds the Display returns to indicate the Input Selection and Volume Level.

BALANCE

The Channel Balance while listening can vary with different program sources. When using Loudspeakers the room acoustics and listening positions also can effect the Channel Balance. Use the Balance Trim Function as needed to achieve approximately equal listening volume levels in each channel. To adjust the Balance perform the following:

1. Momentarily press the Front Panel INPUT Control to enter the TRIM Mode. Then rotate the INPUT Control until "BALANCE: _ dB" appears on the Front Panel Display. Refer to figure 55.



Figure 55

2. Rotate the OUTPUT Control to change the Channel Balance, the range of adjustment is 60dB (to emphasize the Left or Right Channel) in 1 dB steps. Refer to figures 56 and 57.



Figure 56



Figure 57

After approximately 5 seconds the Display returns to indicate the Input Selection and Volume Level.

TRIM LEVEL

Source Components can have slightly different volume levels resulting in the need to readjust the MHA100 Volume Control when switching between different Inputs. The MHA100 allows the adjustment of levels for each of the Inputs for the desired same relative volume. The UNBAL and OPTICAL Inputs are used in the following example.

Note: The TRIM Level Adjustments made are retained in permanent memory.

1. Rotate the INPUT Control to select the UNBAL Input and adjust the VOLUME Control for the desired listening level.
2. Momentarily press the Front Panel INPUT Control to enter the TRIM Mode. Then rotate the INPUT Control until "LEVEL: _ dB" appears on the Front Panel Display. Rotate the OUTPUT Control until the Front Panel Display indicates "LEVEL: 0.0dB". Refer to figure 58.



Figure 58

The range of TRIM Adjustment is ± 6 dB. Refer to figures 59 and 60.



Figure 59



Figure 60

Note: The UNBAL Input is serving as a reference level or choose another Input frequently listened to.

3. Note the current listening level. Then rotate INPUT Control to select the OPTICAL Input and note if the relative volume is louder or quieter than the volume level of the UNBAL.
4. Momentarily press the Front Panel INPUT Control to enter the TRIM Mode. Then rotate the INPUT Control until "LEVEL: _ dB" appears on the Front Panel Display. Using the OUTPUT Control adjust the TRIM Level to match the same relative volume level heard when listening to the UNBAL Input.
5. In our example the relative volume level of the OPTICAL Input is louder than the UNBAL Input, so the trim level for the OPTICAL Input is reduced to -2.5 dB. Refer to figure 61.



Figure 61

6. Repeat steps 1 thru 4 until the relative volume is the same between the UNBAL and OPTICAL Inputs.
7. Repeat the above steps for the remaining inputs with component sources connected until they all have the same relative volume levels. Record any changes made to the various inputs from the default settings in the "Input Trim Settings" Chart on the next page.

After approximately 5 seconds the Display returns to indicate the Input Selection and Volume Level.

MONO/STEREO MODE

By default the Stereo Mode is active for all Input Sources however, any Input Source may be assigned to Mono Mode. To change Stereo Mode to Mono for a given Input Source, perform the following steps:

1. Momentarily press the Front Panel INPUT Control to enter the TRIM Mode. Then rotate the INPUT Control until “MONO / STEREO” appears on the Front Panel Display. Refer to figure 62.



Figure 62

2. Rotate the OUTPUT Control to change the Mode to “Mono”. Refer to figure 63.



Figure 63

After approximately 5 seconds the Display returns to indicate the Input Selection and Volume Level.

Input Trim Settings		
Connection Type	Input Name	New Trim Level
UNBAL		
BALANCED		
OPTICAL		
COAX		
AES/EBU		
USB		

METER BACKLIGHT

The MHA100 Front Panel Meter Illumination may be switched On or Off by performing the following:

1. Momentarily press the Front Panel INPUT Control to enter the TRIM Mode. Then rotate the INPUT Control until “METER BACKLIGHT” appears on the Front Panel Display. Refer to figure 64.
2. Rotate the OUTPUT Control to change illumination to “Off”. Refer to figure 65.



Figure 64



Figure 65

After approximately 5 seconds the Display returns to indicate the Input Selection and Volume Level.

Note: Meter Illumination of contemporary McIntosh Power Amplifiers will also switch On/Off when connected to the MHA100 via a power control cable. Refer to “Power Control Connections” on page 4.

DISPLAY

The MHA100 Front Panel Display Illumination may be switched On or Off by performing the following:

1. Momentarily press the Front Panel INPUT Control to enter the TRIM Mode. Then rotate the INPUT Control until “DISPLAY” appears on the Front Panel Display. Refer to figure 66.



Figure 66

2. Rotate the OUTPUT Control to change the Display to “Off”. Refer to figure 67.



Figure 67

After approximately 5 seconds the Display will switch Off. Any Front Panel Control Operation (or Remote Control Operation such as Input Selection) and the

Display will switch On to indicate current status. Then approximately 5 seconds later the Display will switch Off.

DIGITAL AUDIO

By default, the Digital Audio Display is switched On to display information about the type of digital signal present when a digital input is selected. To switch Off Digital Audio Display perform the following steps:

1. Momentarily press the Front Panel INPUT Control to enter the TRIM Mode. Then rotate the INPUT Control until “DISPLAY” appears on the Front Panel Display. Refer to figure 68.



Figure 68

2. Rotate the OUTPUT Control to change the Display to “Off”. Refer to figure 69.

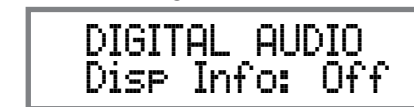

Figure 69

After approximately 5 seconds the Display returns to indicate the Input Selection and Volume Level.

Mute

Press the  MUTE Push-button on the Remote Control to Mute the Audio in the Headphones, Loudspeakers and PRE AMP OUTPUT Jacks. The Front Panel Display will indicate the Input Name and with the word MUTE in place of the actual volume setting. Refer to figure 70.



Figure 70

How to Operate the MHA100, con't

To un-MUTE the Audio press the MUTE Push-button on the Remote Control, adjust the Volume level or change Inputs.

Headphones Jack

Connect a pair of dynamic headphones to the Headphones Jack with a 1/4" (6.3mm) stereo phone type plug for private listening.

Note: Use the OUTPUT Control to select the correct impedance range.

Headphone HXD™

The MHA100 Headphone Crossfeed Director (HXD™) improves the sound localization for Headphone Listening. HXD™ restores the directionality component of the spatial sound stage normally heard with Loudspeaker listening. To activate the HXD when Headphones are connected to the Front Panel Headphone Jack perform the following:

1. Momentarily press the Front Panel VOLUME Control to enable the HXD Mode. The HXD Icon located above the Headphone Jack will illuminate Green. Refer to figure 71.
2. To disable the HXD Mode momentarily press the Front Panel VOLUME Control.



Figure 71

Note: HXD™ Mode is automatically disabled when SPEAKERS are selected with the OUTPUT Control.

Output Control

Rotate the OUTPUT Control to select the desired listening device, Headphones or Loudspeakers. Refer to the OUTPUT CONTROL SELECTION chart below:

- Notes: 1. For the best performance and safety, it is important to always match the impedance of the Headphones and Loudspeakers to the MHA100 Output.*
2. Do not exceed the maximum power handling capacity of Headphones or Loudspeakers connected to the MHA100.
 3. The first time the OUTPUT Control is rotated the Front Panel Display will indicate the current Output selection.

OUTPUT CONTROL SELECTION				
Listening Device	Impedance	Power Level	Output	Refer to figure No.
Loudspeakers	8 ohms	---	50 Watts	71
Headphones	8 to 40 ohms	Norm	250 mWatts	72
Headphones	40 to 150 ohms	Norm	250 mWatts	73
Headphones	150 to 600 ohms	Norm	250 mWatts	74
Headphones	8 to 40 ohms	High	1 Watt	75
Headphones	40 to 150 ohms	High	1 Watts	76
Headphones	150 to 600 ohms	High	1 Watt	77

Profile Mode

The MHA100 has the ability to store up to 5 different Profile Settings for Headphone use. Each profile setting stores the selected Headphone Impedance Range, HXD Setting (On or Off), Bass Boost Setting (0 to +12.5 dB) and assign a custom name for it. In the following example a Profile will be created, recalled, renamed and finally deleted using the Profile Setup Mode:

PROFILE SETTINGS

1. Using the OUTPUT Control select, from the six

INPUT: UNBAL
SPEAKER

Figure 72

INPUT: UNBAL
NORM 8Ω - 40Ω

Figure 73

INPUT: UNBAL
NORM 40Ω - 150Ω

Figure 74

INPUT: UNBAL
NORM 150Ω - 600Ω

Figure 75

INPUT: UNBAL
HIGH 8Ω - 40Ω

Figure 76

INPUT: UNBAL
HIGH 40Ω - 150Ω

Figure 77

INPUT: UNBAL
HIGH 150Ω - 600Ω

Figure 78

choices available, the correct impedance and power output for the Headphones that will be used for listening. Refer to figures 72 thru 78.

- If desired, select the HXD™ Mode by momentarily press the the VOLUME Control. The HXD Icon located above the Headphone Jack will illuminate Green. Refer to figure 71.
- If desired, select the amount of TRIM Bass Boost by momentarily pressing the INPUT Control. Then rotate the INPUT Control to select BASS BOOST followed by using the OUTPUT Control for the desired increase. Refer to figures 53 and 54 on page 21.

CREATE A PROFILE

With the Impedance/Power, HXD and Bass Boost settings made, they will now be assigned to Profile1, for easy recall at a later time. The PROFILE and VOLUME Controls are used to perform the various Profile Functions (Save, Select Rename and Delete). When the PROFILE Control is rotated and there are no saved Profiles the Front Panel Display will indicate the currently selected Input and “NO PROFILE SAVED”. Refer to figure 79.



Figure 79

Create new Profile1 by following the below steps:

- Press and hold in the VOLUME CONTROL until the Front Panel Display indicates “SAVE PROFILE, Profile1”. Refer to figure 80.



Figure 80

- To store “Profile 1” into memory press and hold in

the VOLUME CONTROL until the Front Panel Display indicated “SAVE PROFILE, Profile Saved”. Refer to figure 81.



Figure 81

- To exit the Profile Setup Mode momentarily press the VOLUME Control.

To select a previously saved Profile perform the following steps:

- Rotate the PROFILE Control to select from the available Profiles stored in memory. Refer to figure 82.



Figure 82

Note: The first time the PROFILE Control is rotated, the Front Panel Display will indicate the current Profile selection. Refer to figure 83.



Figure 83

RENAMING A PROFILE

The MHA100 Profile Name (Profile1 thru Profile5 as indicated on the Front Panel Display) can be customized with a different name up to eight characters long (Y10-PRO, etc.). The available characters for renaming the input include the following: ! < > * , / - _ 0 1 2 3 4 5 6 7 8 9 a b c d e f g h i j k l m n o p q r s t u v w x y z A B C D E F G H I J K L M N O P Q R S T U V W X Y Z . In this example the previously created and saved Profile1 will be renamed to “Y10-PRO” by performing the following steps:

- Referring to figure 84, rotate the PROFILE Control to select “NAME PROFILE, Profile1”.



Figure 84

- Press and hold the VOLUME Control until the the character “P” of the “Profile1” starts flashing. Refer to figure 85.



Figure 85

- Rotate the PROFILE Control until the character “Y” appears . Then Rotate the OUTPUT Control until the character “r” of the “Yrprofile1” starts flashing. Refer to figure 86.



Figure 86

- Rotate the PROFILE Control until the character “1” appears. Then rotate the OUTPUT until the character “o” of the “Y1ofile1” starts flashing. Refer to figure 87.



Figure 87

- Repeat steps 9 thru 12 until the new name of “Y10-PRO” is indicated on the Front Panel Display. Refer to figure 88.



Figure 88

How to Operate the MHA100, con't

Profile Mode, con't

14. To store the renamed Profile into memory press and hold in the VOLUME CONTROL until the Front Panel Display indicated “SAVE PROFILE, Profile Saved”. Refer to figure 81.



Figure 81

15. To exit the Profile Rename Mode momentarily press the VOLUME Control.

DELETING PROFILES

There are two ways to Delete Profile(s), delete one saved Profile or delete all saved Profile Names. In the first example one Profile will be deleted. Perform the following steps:

16. Using the Profile Control, select the Profile (1 thru 5) to be deleted. Refer to figure 82.



Figure 82

17. Rotate the Profile Control to select “DELETE PROFILE1”. Refer to figure 89.



Figure 89

18. Press and hold in the VOLUME CONTROL until the Front Panel Display indicates “DELETE PROFILE, Profile Deleted”. Refer to figure 90.



Figure 90

19. To exit the Profile Delete Mode momentarily press the VOLUME Control.

To Delete All the stored Profiles, perform the following steps:

20. Using the Profile Control, select one of the available Profiles (1 thru 5). Refer to figure 91.



Figure 91

21. Rotate the Profile Control to select “DELETE ALL, Saved Profiles”. Refer to figure 92.



Figure 92

22. Press and hold in the VOLUME CONTROL until the Front Panel Display indicates “DELETE ALL, All Deleted”. Refer to figure 93.



Figure 93

23. To exit the Profile Delete Mode momentarily press the VOLUME Control.

Power Output Meters

The MHA100 Power Output Meters indicate the power delivered to the Headphones or Loudspeakers. Refer to figure 100. The meters respond to all the

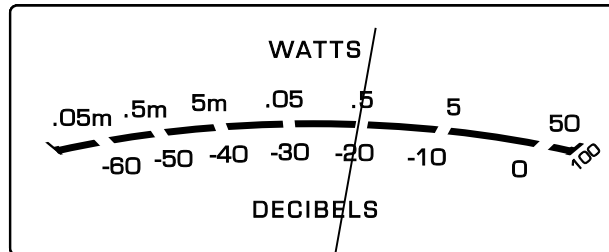

Figure 100

musical information being produced by the Amplifier. They indicate to an accuracy of at least 95% of the power output with only a single cycle of a 2,000Hz tone burst.

Power Guard

During normal operation, the Front Panel Power Guard Indicators will momentarily illuminate during peaks in the audio signals. In the event the MHA100 over heats, due to improper ventilation, high ambient temperature and/or impedance mismatch, the internal protection circuits will activate. The Front Panel Power Guard Indicators will continuously illuminate and the audio will be muted. When the MHA100 has returned to a safe operating temperature, normal operation will resume.

Using a Separate Power Amplifier or Subwoofer

To use a separate amplifier instead of the MHA100 built-in Power Amplifier, connect the Loudspeakers to the separate power amplifier. Refer to page 13 “External Power Amplifier Connections” for additional connection information. An external Powered Subwoofer may also be used with the MHA100. Refer to page 19 “Subwoofer Mode” for additional information.

When either an External Power Amplifier or Power Subwoofer is used with the MHA100 the Rear Panel PREAMP OUTPUT Jacks are used. Refer to figure 101.

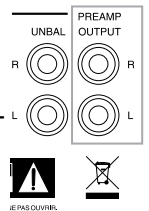

Figure 101

System Thru Operation

When the MHA100 is connected to a Main Pre-amplifier or Audio/Video Controller (as illustrated on page 12) it is important to maximize the combined

performance. For the best performance, the volume control on the MHA100 should be set to 70%. The Volume Control on the Main Preamplifier or Audio/Video Controller should be used to adjust the listening volume level.

Digital Inputs

When a Digital Input (Optical, Coax or AES/EBU Connection) on the MHA100 is selected the Front Panel Display will indicate the Sampling Frequency when a signal is present “48K”. Refer to figure 102. During the time there is no Digital Signal present the display will indicate “SILENT”. Refer to figure 103.



Figure 102



Figure 103

USB Input Operation and Driver Installation

The MHA100 USB Input provides the capability to playback music from a computer when the MHA100 Rear Panel USB Connector is connected to a computer USB Connector. Refer to page 11 Connecting Components.

Note: The USB Input is for direct connection to a computer only. To playback music from a USB Drive, connect the USB Drive to another USB Port on the computer and select the USB Drive with the Media Playback Program.

The MHA100 USB Input is compatible with PC Computers using Microsoft® Windows® Vista (SP2), Windows 7 (SP1) and Windows 8 (SP1). It is also compatible with Apple® Macintosh® Computers using OS-10.9 Mavericks or later.

When using a PC Computer with Windows, a special McIntosh USB Audio Software Driver needs to be installed on the PC Computer. The driver needs to be installed before connecting the MHA100 USB Input to the USB Port on the computer.

Note: If an Apple Macintosh computer is used with the MHA100, no additional driver is required.

The McIntosh USB Audio Windows Driver is available for download from the McIntosh Web Site: <http://www.mcintoshlabs.com/us/support/Pages/Manuals.aspx>

Under “Products” select “McIntosh MHA100” then scroll down to the bottom of the McIntosh MHA100 to the “DOWNLOAD AREA”. Select the “McIntosh MHA100 PC DRIVER SETUP” and download the PC Windows Driver. Follow the instructions below to install the McIntosh MHA100 Driver:

Purpose:

To Install the McIntosh USB Audio Windows Driver for use with McIntosh MHA100 with an USB-Digital Audio Input.

Requirements:

1. A functioning McIntosh MHA100 with an USB-Digital Audio Input.
2. A PC Computer with a **genuine Intel** Main Processor and a functioning USB Port.
3. Windows Vista (SP2), Windows 7 (SP1 or greater) or Windows 8.1 Operating System.
4. An USB Cable with Type A to Type B Connectors.

Installing the Software

It is important to first install the downloaded software on your computer before connecting the McIntosh MHA100 to the computer. The USB Driver is included in the downloaded software package.

Note: Before installing this software, please check to see if the McIntosh MHA100 has the latest firmware version, if not update the firmware first.

1. Unzip the downloaded McIntosh Windows USB Driver Software Package.
2. Run “McIntosh_USB_driver_..exe”. Refer to figures 104 and 105.



Figure 104



Figure 105

3. Referring to figure 106, read and then check the “I accept the terms of the License Agreement” box and then the Next > button. If desired, choose a Start Menu Folder. Refer to figure 107.

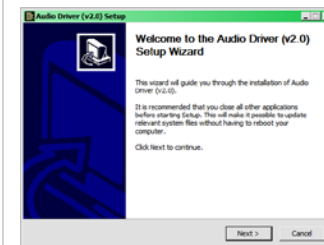

Figure 106



Figure 107

4. When the Windows Security window appears click on the “Install” button. Refer to figures 108 thru 111 on the next page.

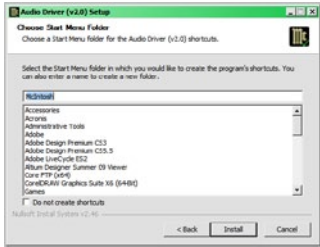

Figure 108

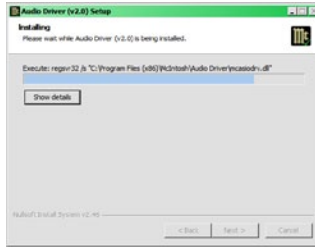

Figure 109

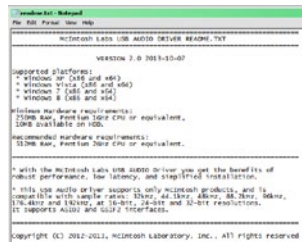

Figure 110



Figure 111

USB Connection

Connect the USB Cable with Type A to Type B connectors between the PC Computer and the McIntosh MHA100 with the USB-Digital Audio Input. An Icon will appear On-Screen indicating Windows has found new hardware. Refer to figure 112.

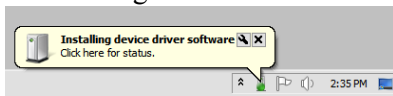

Figure 112

Referring to figure 113, check the *Always trust software from "CEEntrance, Inc."* box and then the Install button. Upon completion of installing the driver, figure 114 will appear.

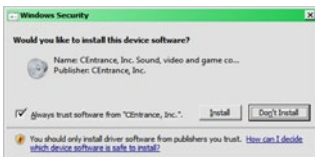

Figure 113

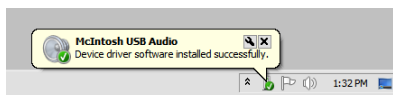

Figure 114

Windows Sound Settings

For proper operation of the McIntosh MHA100 via the Computer USB Connection, it is required to make changes to Windows Sound Settings:

1. Click on the "McIntosh ICON" (located in the Windows notification area on the right side of the taskbar) or click on the Windows "Show hidden icons", then select the "McIntosh ICON". Refer to figures 115, 116 and 117.



Figure 115

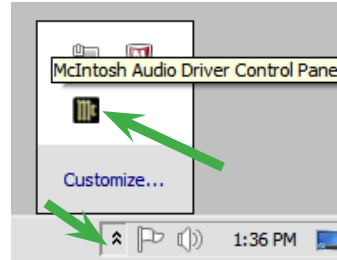

Figure 116

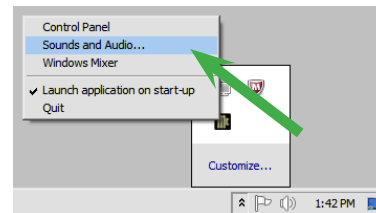

Figure 117

Note: Some version(s) of Windows might not show the McIntosh Icon. Click on the "Start" button, select "Control Panel", then "Sound". Proceed to step 3.

2. Right mouse button click to bring up the menu and then select the "Sound and Audio....". Refer to figures 118 and 119.
3. Select the "Speakers McIntosh USB Audio" and then click on the SET DEFAULT button. Refer to figures 120 and 121.

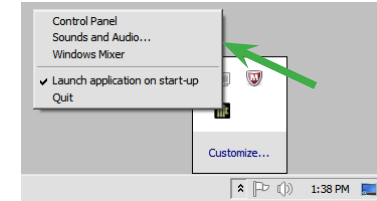

Figure 118

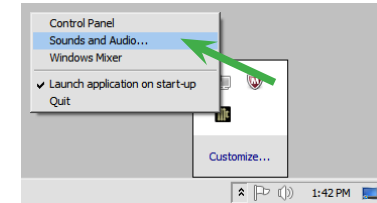

Figure 119

Notes: 1. When the McIntosh USB Audio MHA100 is not connected to your computer, the previous default Audio Device will be selected. 2. If other McIntosh Product(s) with USB Audio Connections are also connected to the computer, an additional "McIntosh USB Audio" playback device will appear in the listing. Make sure to select the "McIntosh USB Audio Device" from available playback devices listed when using this McIntosh MHA100 for USB Audio.

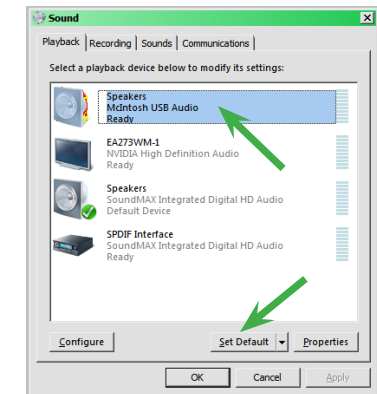

Figure 120

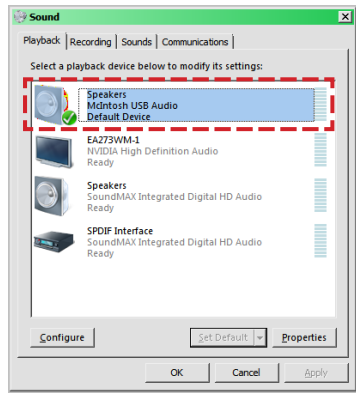

Figure 121

USB Audio Driver Operation

Control Panel Settings

The MHA100 USB Control Panel allows changes to be made from the default settings. These include Latency, Sample Rate and Audio Stream Input Output (ASIO) Control. Refer to figure 122.

Note: It is not necessary for the McIntosh USB Control Panel to be running, unless it is desired to make changes to the default settings.

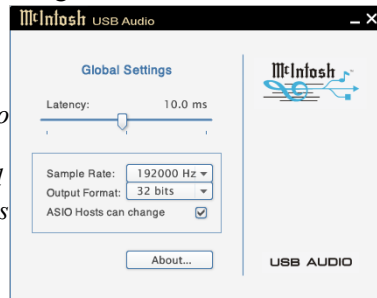

Figure 122

LATENCY:

The default Latency Setting is chosen for contemporary computers and their performance capabilities. When the McIntosh USB Audio Driver is installed on a legacy computer with slower processing speed, it may occasionally produce clicks/pops in the music. To resolve this if it occurs, increase the Latency Setting (increase buffer size).

SAMPLE RATE:

The Sample Rate pull down Window indicates the Sample Rate choices of the connected McIntosh MHA100. It also communicates the selected choice of Sampling Rate to the active Windows Playback Program.

Note: In general, when the original music is recorded at a higher Sampling Rate, the result is usually more detail in the music. However, this higher rate results in consuming larger amounts of storage space. The Sample Rate usually should be set to match the Sample Rate of the music recording being played back.

ASIO HOSTS CAN CHANGE:

There are two choices. When the box is not checked (default setting), the Sample Rate is determined by the Sample Rate Setting in the McIntosh USB Control Panel. It would be an appropriate choice when using a playback program like Windows Media Player.

If a third party program for music playback is ASIO compliant then check the box. These programs allow changing the Sample Rate Setting directly “on the fly” according to the format of the music being played back. An example of just one of the available programs is “JRiver Media Center”.

ABOUT:

Displays the Driver Version and Control Panel Version of the current McIntosh USB Audio Driver. Refer to figure 123.



Figure 123

Reset of Microprocessors

In the unlikely event the controls of the MHA100 stop functioning, the microprocessors can be reset by performing the following:

1. Press the STANDBY/ON Push-button until the STANDBY/ON Indicator switches Off.
2. When the MHA100 cycles On then Off, release the STANDBY/ON Push-button.
3. When the STANDBY/ON LED is illuminated press the STANDBY/ON Push-button, the MHA100 will resume normal operation.

Note: This can be performed with the MHA100 On or in the Standby Mode.

Resetting the MHA100 to default settings

If it becomes desirable to reset all the adjustable settings (Setup and Trim Settings) to the factory default values, perform the following:

1. Press in and hold the INPUT Control and the VOLUME Control. The Front Panel Display will indicate “FACTORY RESET”. Refer to figure 124.



Figure 124

2. When the Front Panel Display indicates “FACTORY RESET, COMPLETE” release the two controls. Refer to figure 125.



Figure 125

3. Press the STANDBY/ON Push-button and the MHA100 will resume operation.



Amplifier Specifications

Loudspeaker Power Output

50 watts is the minimum sine wave continuous average power output per channel, both channels operating

Headphone Power Output

1 watt - High Selection
250mWatts - Norm Selection

Loudspeaker Output Load Impedance

8 ohms

Headphone Output Load Impedance

8 - 40 ohms
40 - 150 ohms
150 - 600 ohms

Rated Power Band

20Hz to 20,000Hz

Total Harmonic Distortion

0.005% maximum with both channels operating from 250 milliwatts to rated power, 20Hz to 20,000Hz

Dynamic Headroom (Loudspeaker)

1.5dB

Frequency Response

+0, -0.5dB from 20Hz to 20,000Hz
+0, -3dB from 10Hz to 100,000Hz

Tone Control

Bass Boost 0 to +12.5dB (2.5dB steps) @ 40Hz

Preamplifier Output (for rated input)

3V (8V Maximun)

Signal To Noise Ratio (A-Weighted)

High Level, 105dB below rated output

Sensitivity (for rated output)

300mV unbalanced
600mV balanced

Intermodulation Distortion

0.005% maximum, if the instantaneous peak power is 100 watts or less per channel with both channels operating for any combination of frequencies from 20Hz to 20,000Hz

Wide Band Damping Factor

Greater than 150

Input Impedance

25K ohms unbalanced
25K ohms balanced

Maximum Input Signal

8V unbalanced
16V balanced

Preamplifier Output Impedance

500 ohms

Power Guard

Less than 2% THD with up to 16dB overdrive at 1,000Hz

Voltage Gain

36.5dB

Digital Input Sample Rates

Optical: 16Bit, 24Bit - 32kHz to 192kHz
Coaxial: 16Bit, 24Bit - 32kHz to 192kHz
AES/EBU: 16Bit, 24Bit - 32kHz to 192kHz
USB: 16Bit, 24Bit, 32Bit - 32kHz to 192kHz

Power Control Input

5-15VDC, < 1mA

Power Control Output

12VDC, 25mA maximum

General Specifications

Power Requirements

Field AC Voltage conversion of the MHA100 is not possible. The MHA100 is factory configured for one of the following AC Voltages:

100 Volts, 50/60Hz at 1.8 amps
110 Volts, 50/60Hz at 1.5 amps
120 Volts, 50/60Hz at 1.5 amps
220 Volts, 50/60Hz at 0.9 amps
230 Volts, 50/60Hz at 0.8 amps
240 Volts, 50/60Hz at 0.8 amps
Standby: Less than 0.25 watt

Note: Refer to the rear panel of the MHA100 for the correct voltage.

Overall Dimensions

Width is 11-1/2 inches (29.2cm)
Height is 5-9/16 inches (14.1cm) including feet
Depth is 18 inches (45.7cm) including the Front Panel, Knobs and Cables

Weight

26.5 pounds (12 kg) net, 32.5 pounds (14.8 kg) in shipping carton

Shipping Carton Dimensions

Width is 19-3/8 inches (49.2cm)
Depth is 16-1/4 inches (41.3cm)
Height is 14-3/4 inches (37.5cm)

Packing Instructions

In the event it is necessary to repack the equipment for shipment, the equipment must be packed exactly as shown below. It is very important that the four plastic feet are attached to the bottom of the equipment. Failure to do this will result in shipping damage.

Use the original shipping carton and interior parts only if they are all in good serviceable condition. If a shipping carton or any of the interior part(s) are needed, please call or write Customer Service Department of McIntosh Laboratory. Refer to page 3. Please see the Part List for the correct part numbers.

MHA100 Packing Material List

Quantity	Part Number	Description
1	034548	Shipping carton
1	034558	Left foam end cap
1	034557	Right foam end cap
1	034559	Corrugated wrap
4	163073	Plastic foot
4	400131	#10-32 x 1/2 machine screw

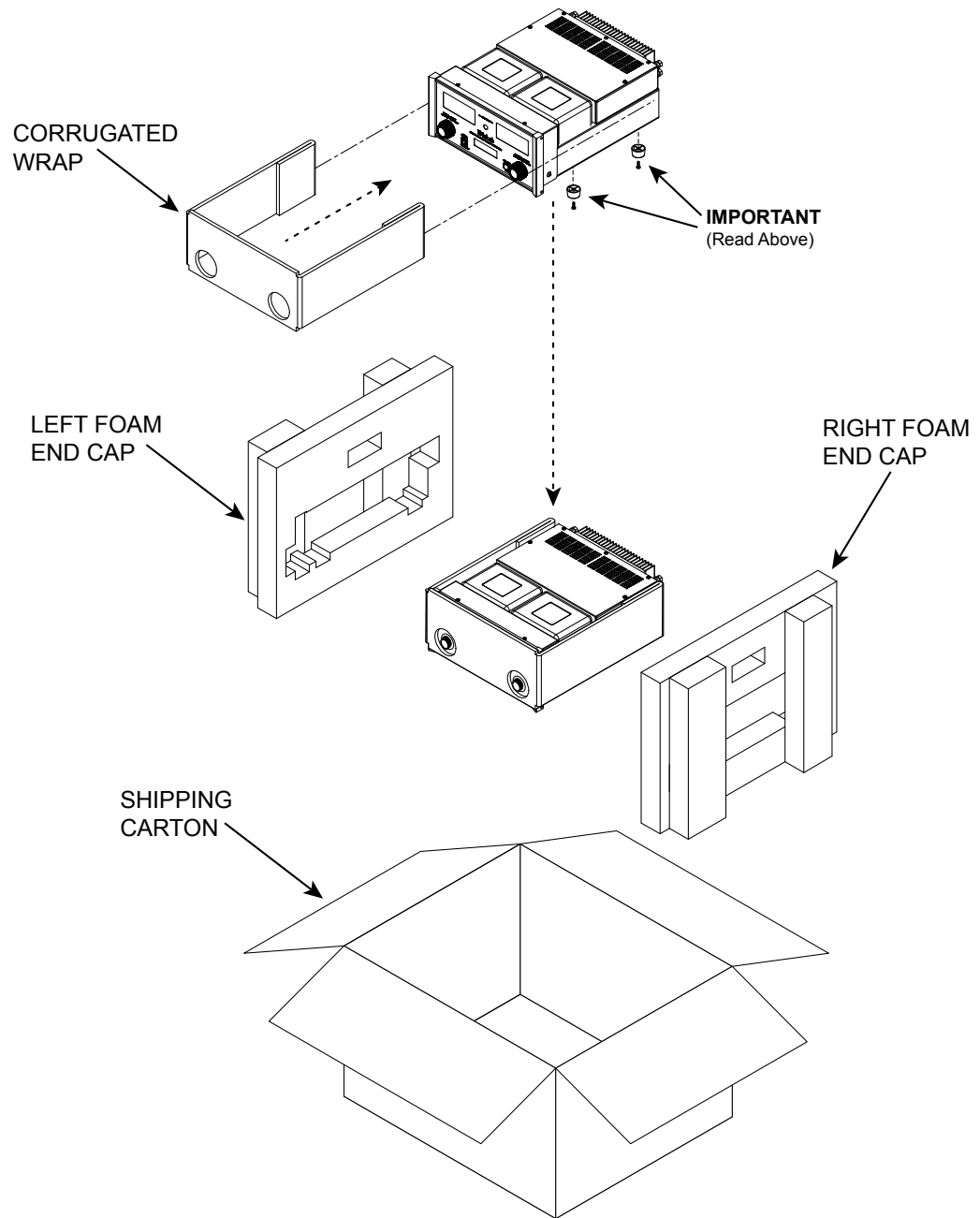



McIntosh Laboratory, Inc.
2 Chambers Street
Binghamton, NY 13903
www.mcintoshlabs.com

The continuous improvement of its products is the policy of McIntosh Laboratory Incorporated who reserve the right to improve design without notice.
Printed in the U.S.A.